

# MOTODA Ψman

MOTODA presents Balancer which is friendly to human being



**MOTODA GIKEN LIMITED**

 台北貿易

# YMAN-

源自於大猩猩學名yman，因其力氣大而來。

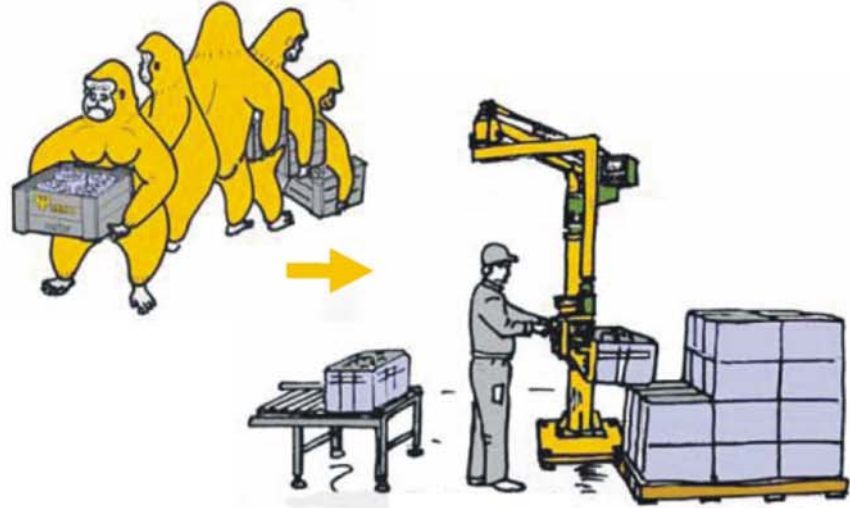

## 特性

迅速性  
 安全性  
 簡易性  
 準確性

- 利用操作手臂之操作桿上下動作即可輕易移動重物。
- 精巧的手臂機構，可做到水平、傾斜，三次元等移動及旋轉動作。

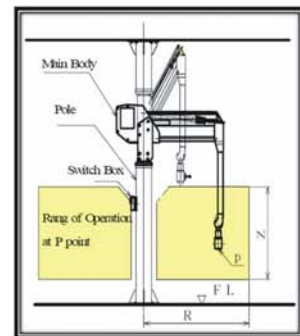
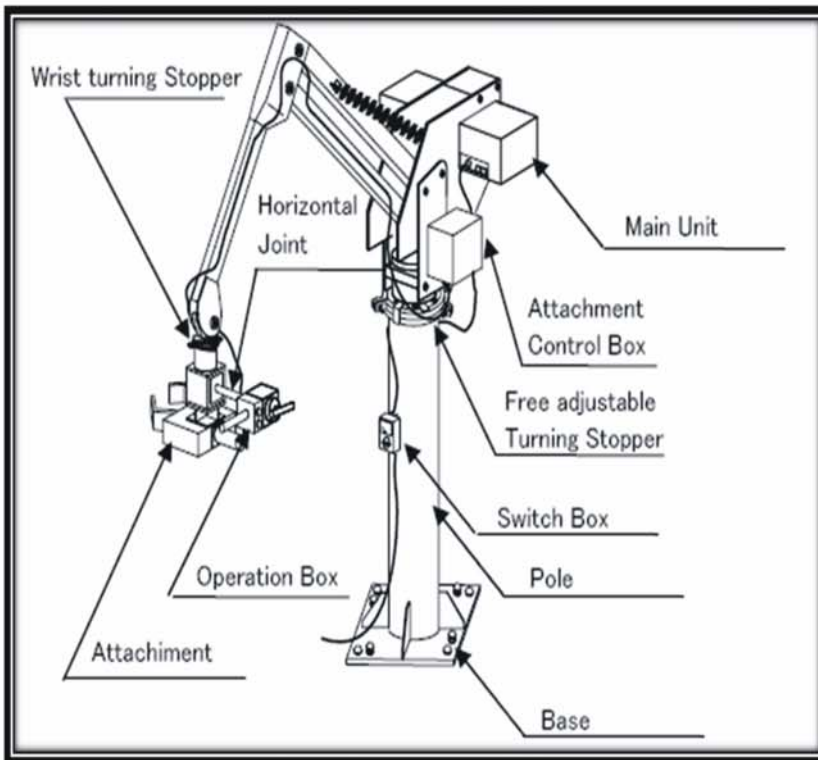

**B TYPE**

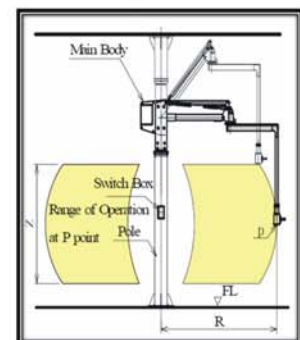

**E TYPE**

# 適用作業



處理搬運困難、重量重且作業僅需一人之作業  
 作業人員困難或無法直接接觸搬運物之作業  
 處理之工作需保持場區安全及衛生之作業  
 處理對象須避免損傷搬運物之作業



## 安裝方式:

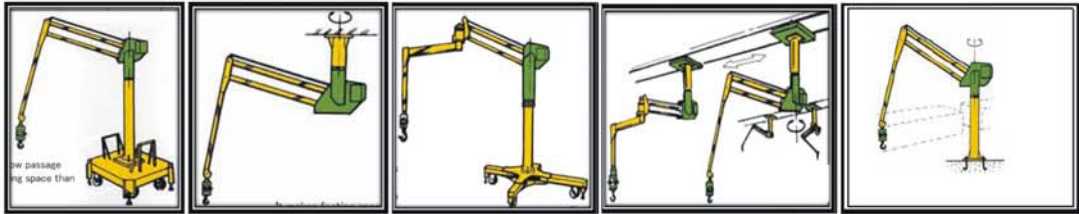

## 參考治具:

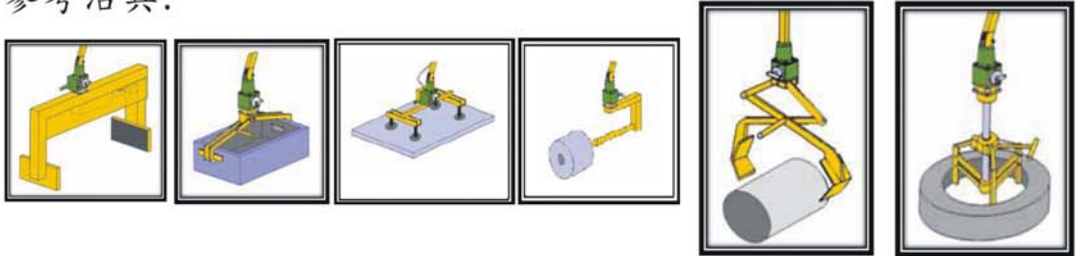



B type 規格表					
型號	提昇距離 (mm)	迴轉半徑 (mm)	承載力 (kg)	提昇速度 (m/min)	高速型/提昇速度 (m/min)
MY-BS-104	1450	2000	100	0~20	0~35
MY-BS-105	1900	2500	85		
MY-BS-106	2250	3000	75		
MY-BS-184	1450	2000	180	0~18	0~30
MY-BS-185	1900	2500	150		
MY-BS-186	2250	3000	120		
MY-BS-254	1450	2000	250	0~12	0~24
MY-BS-255	1900	2500	215		
MY-BS-256	2250	3000	185		

E type 規格表					
型號	提昇距離 (mm)	迴轉半徑 (mm)	承載力 (kg)	提昇速度 (m/min)	高速型/提昇速度 (m/min)
MY-ES-104	1450	2000	100	0~20	0~35
MY-ES-105	1750	2500	75		
MY-ES-106	2000	3000	60		
MY-ES-184	1450	2000	180	0~20	0~35
MY-ES-185	1750	2500	145		
MY-ES-186	2000	3000	110		
MY-ES-254	1450	2000	250	0~12	0~24
MY-ES-255	1750	2500	200		
MY-ES-256	2000	3000	165		

 台北貿易股份有限公司  
 TAIPEI TRADING CO., LTD.

總公司  
 台北市松江路363號7樓  
 TEL:(02)2503-5688

 上海台貿機械設備維修有限公司  
 SHANGHAI TTC MACHINERY

上海市松江區倉橋領玉佳路30號  
 TEL:(021)6772-5150  
 FAX:(021)6772-6656

